

Fittings Catalogue

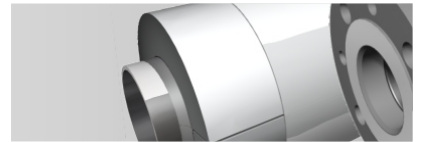

insulock pipe insulation system



Table of Contents

Page	Information Sheet
2	Long/Short 90° Elbows White
3	45° Elbows White
4	Tees white
5	End Caps White
6	A20 Regular PVC
7	A30 PVC
8	Exo 20 High Temperature PVC
9	Exo 20 High Temperature End Caps
10	Long Radius 90° Elbows
15	Line Flange Cover
16	EXL - Line Flange Cover
18	Concentric Cone Reducer
19	Flanged Gate Valve
20	90° Flanged Elbow
22	90° Reducer Elbow
24	45° Reducer Elbow
26	Flanged Tee
28	Reducer Tee
30	Victaulic 90° Elbow
31	Victaulic 90° Long Radius Elbow
32	Victaulic 45° Elbow
33	Victaulic Grooved Coupling
34	Victaulic Valve Tee Covers
35	PVC Sizing Charts
37	Terms and Conditions



Combination* Long/short 90° elbows white

- White UV Stable.
- Please refer to sizing chart for correct radius

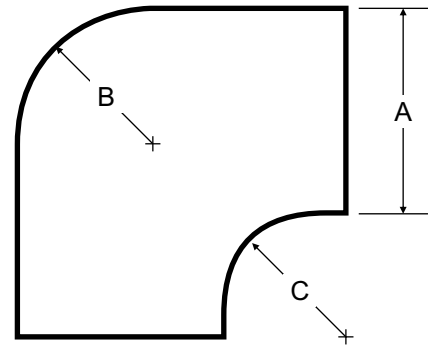
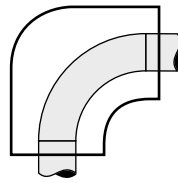
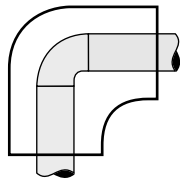

✓ These white fittings generally available ex stock.

× Available on special order. Conditions apply.

* Contact Factory for measurements.

Max Insulation O.D.
Coverable

Size	A-mm	inches	B-mm	C-mm	
2	41	1 5/8	27	10	✓
3	48	1 7/8	40	15	✓
4	54	2 1/8	40	20	✓
5	60	2 3/8	50	20	✓
6	67	2 5/8	50	20	✓
7	73	2 7/8	50	20	✓
8	80	3 1/8	60	30	✓
9	89	3 1/2	60	30	✓
10	102	4	80	30	✓
11	114	4 1/2	207	40	✓
12	127	5	234	60	✓
13	141	5 9/16	273	60	✓
14	152	6 1/8	278	70	✓
15	168	6 5/8	307	65	✓
16	178	7 1/8	384	65	✓
17	194	7 5/8	381	65	✓
18	216	8 5/8	365	80	✓
19	241	9 5/8	413	65	✓
20	267	10 3/4	445	70	✓
21	289	11 3/4	507	90	✓

Max Insulation O.D.
Coverable

Size	A-mm	inches	B-mm	C-mm	\$ ea	
22	324	12 3/4	260	80		✓
23	356	14	*	*	P.O.A	×
24	381	15	*	*	P.O.A	×
25	407	16	*	*	P.O.A	×
26	432	17	*	*	P.O.A	×
27	457	18	*	*	P.O.A	×
28	483	19	*	*	P.O.A	×
29	508	20	*	*	P.O.A	×
30	534	21	*	*	P.O.A	×
31	559	22	*	*	P.O.A	×
32	584	23	*	*	P.O.A	×
33	610	24	*	*	P.O.A	×
34	635	25	*	*	P.O.A	×
35	660	26	*	*	P.O.A	×
36	686	27	*	*	P.O.A	×
37	711	28	*	*	P.O.A	×
38	737	29	*	*	P.O.A	×
39	762	30	*	*	P.O.A	×
40	787	31	*	*	P.O.A	×
41	813	32	*	*	P.O.A	×



45° elbows white

- All 45° elbows suit long and short radius bends.
- White UV Stable.

✓ These white fittings generally available ex stock.

× Available on special order. Conditions apply.

* Contact Factory for measurements.

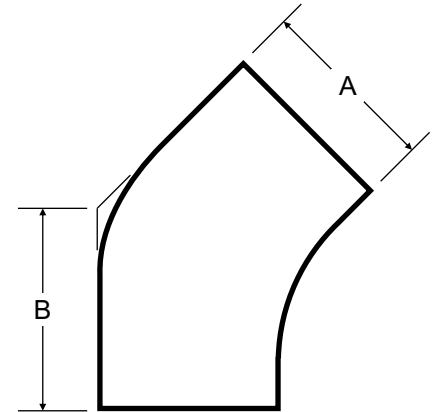

Max Insulation O.D.

Max Insulation O.D. Coverable

Size	A-mm	inches	B-mm	
2	41	1 5/8	27	✓
3	48	1 7/8	35	✓
4	54	2 1/8	35	✓
5	60	2 3/8	45	✓
6	67	2 5/8	42	✓
7	73	2 7/8	45	✓
8	80	3 1/8	38	✓
9	89	3 1/2	50	✓
10	102	4	55	✓
11	114	4 1/2	58	✓
12	127	5	60	✓
13	141	5 9/16	60	✓
14	152	6 1/8	65	✓
15	168	6 5/8	68	✓
16	178	7 1/8	75	✓
17	194	7 5/8	77	✓
18	216	8 5/8	100	✓
19	241	9 5/8	100	✓
20	267	10 3/4	105	✓
21	289	11 3/4	107	✓

Size	A-mm	inches	B-mm	\$ ea	
22	324	12 3/4	130		✓
23	356	14	*	P.O.A	×
24	381	15	*	P.O.A	×
25	407	16	*	P.O.A	×
26	432	17	*	P.O.A	×
27	457	18	*	P.O.A	×
28	483	19	*	P.O.A	×
29	508	20	*	P.O.A	×
30	534	21	*	P.O.A	×
31	559	22	*	P.O.A	×
32	584	23	*	P.O.A	×
33	610	24	*	P.O.A	×
34	635	25	*	P.O.A	×
35	660	26	*	P.O.A	×
36	686	27	*	P.O.A	×
37	711	28	*	P.O.A	×
38	737	29	*	P.O.A	×
39	762	30	*	P.O.A	×
40	787	31	*	P.O.A	×
41	813	32	*	P.O.A	×



Tees white

Suitable for small screwed valves

- Branch out leg incorporates blank end to allow use as equal or reducer tee.
- White UV Stable.

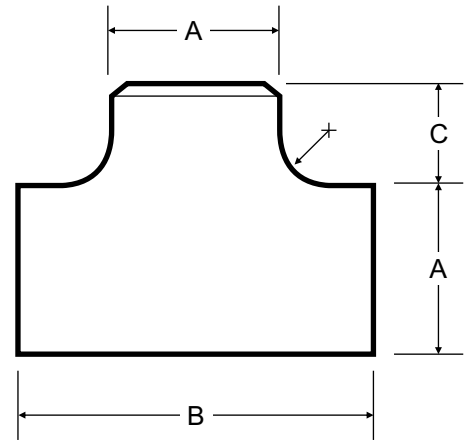
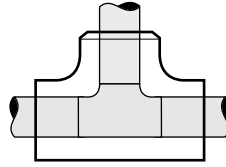

✓ These white fittings generally available ex stock.

× Available on special order. Conditions apply.

* Contact Factory for measurements.

Max Insulation O.D. Coverable

Max Insulation O.D. Coverable

Size	A-mm	inches	B-mm	C-mm	
2	41	1 5/8	95	20	✓
3	48	1 7/8	95	27	✓
4	54	2 1/8	103	24	✓
5	60	2 3/8	120	31	✓
6	67	2 5/8	132	29	✓
7	73	2 7/8	132	40	✓
8	80	3 1/8	195	39	✓
9	89	3 1/2	180	60	✓
10	102	4	195	50	✓
11	114	4 1/2	207	50	✓
12	127	5	234	55	✓
13	141	5 9/16	273	62	✓
14	152	6 1/8	278	73	✓
15	168	6 5/8	307	80	✓
16	178	7 1/8	384	92	✓
17	194	7 5/8	381	85	✓
18	216	8 5/8	365	75	✓
19	241	9 5/8	413	105	✓
20	267	10 3/4	445	95	✓
21	289	11 3/4	507	160	✓

Size	A-mm	inches	B-mm	C-mm		
22	324	12 3/4	582	165		✓
23	356	14	619	140	P.O.A	×
24	381	15	620	145	P.O.A	×
25	407	16	653	155	P.O.A	×
26	432	17	*	*	P.O.A	×
27	457	18	*	*	P.O.A	×
28	483	19	*	*	P.O.A	×
29	508	20	*	*	P.O.A	×
30	534	21	*	*	P.O.A	×
31	559	22	*	*	P.O.A	×
32	584	23	*	*	P.O.A	×
33	610	24	*	*	P.O.A	×
34	635	25	*	*	P.O.A	×
35	660	26	*	*	P.O.A	×
36	686	27	*	*	P.O.A	×
37	711	28	*	*	P.O.A	×
38	737	29	*	*	P.O.A	×
39	762	30	*	*	P.O.A	×
40	787	31	*	*	P.O.A	×
41	813	32	*	*	P.O.A	×



End caps

- White UV Stable.

✓ These white fittings generally available ex stock.

× Available on special order. Conditions apply.

* Contact Factory for measurements.

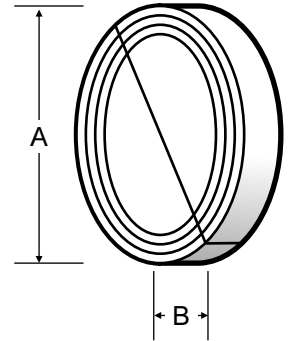

Max Insulation O.D. Coverable

Size	A-mm	inches	B-mm	
2	41	1 5/8	25	✓
3	48	1 7/8	20	✓
4	54	2 1/8	20	✓
5	60	2 3/8	20	✓
6	67	2 5/8	25	✓
7	73	2 7/8	35	✓
8	80	3 1/8	35	✓
9	89	3 1/2	40	✓
10	102	4	40	✓
11	114	4 1/2	35	✓
12	127	5	40	✓
13	141	5 9/16	25	✓
14	152	6 1/8	35	✓
15	168	6 5/8	40	✓
16	178	7 1/8	40	✓
17	194	7 5/8	40	✓
18	216	8 5/8	40	✓
19	241	9 5/8	40	✓
20	267	10 3/4	45	✓
21	289	11 3/4	45	✓

Max Insulation O.D. Coverable

Size	A-mm	inches	B-mm	
22	324	12 3/4	45	✓
23	356	14	35	×
24	381	15	35	×
25	407	16	35	×
26	432	17	35	×
27	457	18	35	×
28	483	19	35	×
29	508	20	70	×
30	534	21	40	×
31	559	22	*	×
32	584	23	65	×
33	610	24	*	×
34	635	25	*	×
35	660	26	*	×
36	686	27	*	×
37	711	28	*	×
38	737	29	*	×
39	762	30	*	×
40	787	31	*	×
41	813	32	*	×



A20 regular PVC

- Price for PVC cladding only - insulation sold separately
- White UV Stable.

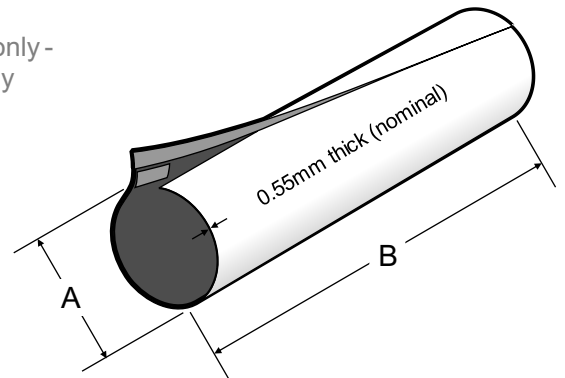

Max Insulation O.D. Coverable

Size	A-mm	inches	B-mm	C-mm	
2	41	1 5/8	1220	25	Not Manufactured
3	48	1 7/8	1220	25	Not Manufactured
4	54	2 1/8	1220	25	✓
5	60	2 3/8	1220	25	✓
6	67	2 5/8	1220	38	✓
7	73	2 7/8	1220	38	✓
8	80	3 1/8	1220	38	✓
9	89	3 1/2	1220	38	✓
10	102	4	1220	38	✓
11	114	4 1/2	1220	38	✓
12	127	5	1220	38	✓
13	141	5 9/16	1220	50	✓
14	152	6 1/8	1220	50	✓
15	168	6 5/8	1220	50	✓
16	178	7 1/8	1220	50	✓
17	194	7 5/8	1220	50	✓
18	216	8 5/8	1220	50	✓
19	241	9 5/8	1220	50	✓
20	267	10 3/4	1220	75	✓
21	289	11 3/4	1220	75	✓

Max Insulation O.D. Coverable

Size	A-mm	inches	B-mm	C-mm	
22	324	12 3/4	1220	75	✓
23	356	14	1220	75	×
24	381	15	1220	75	×
25	407	16	1220	75	×
26	432	17	1220	100	×
27	457	18	1220	100	×
28	483	19	1220	100	×
29	508	20	1220	100	×
30	534	21	1220	100	×
31	559	22	1220	100	×
32	584	23	1220	100	×
33	610	24	1220	100	×
34	635	25	1220	100	×
35	660	26	1220	100	×
36	686	27	1220	100	×
37	711	28	1220	100	×
38	737	29	1220	100	×
39	762	30	1220	100	×
40	787	31	1220	100	×
41	813	32	1220	100	×



A30 PVC

- Price for PVC cladding only—insulation sold separately
- White UV Stable.

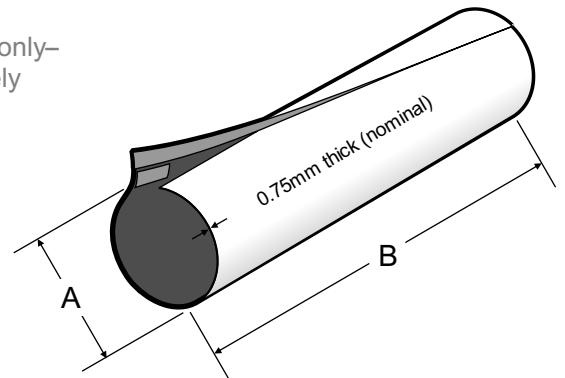

Max Insulation O.D. Coverable

Size	A-mm	inches	B-mm	C-mm	
2	41	1 5/8	1220	25	Not Manufactured
3	48	1 7/8	1220	25	Not Manufactured
4	54	2 1/8	1220	25	Not Manufactured
5	60	2 3/8	1220	25	Not Manufactured
6	67	2 5/8	1220	38	Not Manufactured
7	73	2 7/8	1220	38	Not Manufactured
8	80	3 1/8	1220	38	Not Manufactured
9	89	3 1/2	1220	38	Not Manufactured
10	102	4	1220	38	Not Manufactured
11	114	4 1/2	1220	38	Not Manufactured
12	127	5	1220	38	✓
13	141	5 9/16	1220	50	✓
14	152	6 1/8	1220	50	✓
15	168	6 5/8	1220	50	✓
16	178	7 1/8	1220	50	✓
17	194	7 5/8	1220	50	✓
18	216	8 5/8	1220	50	✓
19	241	9 5/8	1220	50	✓
20	267	10 3/4	1220	75	✓
21	289	11 3/4	1220	75	✓

Max Insulation O.D. Coverable

Size	A-mm	inches	B-mm	C-mm		
22	324	12 3/4	1220	75		✓
23	356	14	1220	75	P.O.A	×
24	381	15	1220	75	P.O.A	×
25	407	16	1220	75	P.O.A	×
26	432	17	1220	100	P.O.A	×
27	457	18	1220	100	P.O.A	×
28	483	19	1220	100	P.O.A	×
29	508	20	1220	100	P.O.A	×
30	534	21	1220	100	P.O.A	×
31	559	22	1220	100	P.O.A	×
32	584	23	1220	100	P.O.A	×
33	610	24	1220	100	P.O.A	×
34	635	25	1220	100	P.O.A	×
35	660	26	1220	100	P.O.A	×
36	686	27	1220	100	P.O.A	×
37	711	28	1220	100	P.O.A	×
38	737	29	1220	100	P.O.A	×
39	762	30	1220	100	P.O.A	×
40	787	31	1220	100	P.O.A	×
41	813	32	1220	100	P.O.A	×



Exo20 high temperature PVC

- Price for PVC cladding only - insulation sold separately
- White UV Stable.

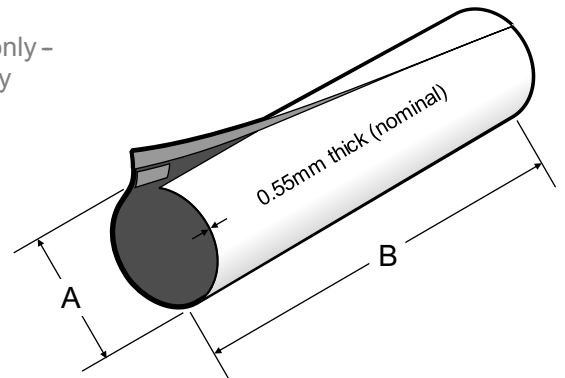

Max Insulation O.D. Coverable

Size	A-mm	inches	B-mm	C-mm	
2	41	1 5/8	1220	25	Not Manufactured
3	48	1 7/8	1220	25	Not Manufactured
4	54	2 1/8	1220	25	✓
5	60	2 3/8	1220	25	✓
6	67	2 5/8	1220	38	✓
7	73	2 7/8	1220	38	✓
8	80	3 1/8	1220	38	✓
9	89	3 1/2	1220	38	✓
10	102	4	1220	38	✓
11	114	4 1/2	1220	38	✓
12	127	5	1220	38	✓
13	141	5 9/16	1220	50	✓
14	152	6 1/8	1220	50	✓
15	168	6 5/8	1220	50	✓
16	178	7 1/8	1220	50	✓
17	194	7 5/8	1220	50	✓
18	216	8 5/8	1220	50	✓
19	241	9 5/8	1220	50	✓
20	267	10 3/4	1220	75	✓
21	289	11 3/4	1220	75	✓

Max Insulation O.D. Coverable

Size	A-mm	inches	B-mm	C-mm		
22	324	12 3/4	1220	75		✓
23	356	14	1220	75	P.O.A	×
24	381	15	1220	75	P.O.A	×
25	407	16	1220	75	P.O.A	×
26	432	17	1220	100	P.O.A	×
27	457	18	1220	100	P.O.A	×
28	483	19	1220	100	P.O.A	×
29	508	20	1220	100	P.O.A	×
30	534	21	1220	100	P.O.A	×
31	559	22	1220	100	P.O.A	×
32	584	23	1220	100	P.O.A	×
33	610	24	1220	100	P.O.A	×
34	635	25	1220	100	P.O.A	×
35	660	26	1220	100	P.O.A	×
36	686	27	1220	100	P.O.A	×
37	711	28	1220	100	P.O.A	×
38	737	29	1220	100	P.O.A	×
39	762	30	1220	100	P.O.A	×
40	787	31	1220	100	P.O.A	×
41	813	32	1220	100	P.O.A	×



Exo20 high temperature end caps

- White UV Stable.

✓ These white fittings generally available ex stock.

× Available on special order. Conditions apply.

* Contact Factory for measurements.

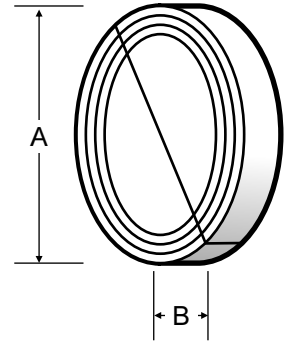

Max Insulation O.D. Coverable

Size	A-mm	inches	B-mm		
2	41		Not Available		
3	48		Not Available		
4	54		Not Available		
5	60		Not Available		
6	67	2 5/8	25	✓	
7	73	2 7/8	35	✓	
8	80	3 1/8	35	✓	
9	89	3 1/2	40	✓	
10	102	4	40	✓	
11	114	4 1/2	35	✓	
12	127	5	40	✓	
13	141	5 9/16	25	✓	
14	152	6 1/8	35	✓	
15	168	6 5/8	40	✓	
16	178	7 1/8	40	✓	
17	194	7 5/8	40	✓	
18	216	8 5/8	40	✓	
19	241	9 5/8	40	P.O.A	×
20	267	10 3/4	45	P.O.A	×
21	289	11 3/4	45	P.O.A	×

Max Insulation O.D. Coverable

Size	A-mm	inches	B-mm		
22	324	12 3/4	45	P.O.A	×
23	356	14	35	P.O.A	×
24	381	15	35	P.O.A	×
25	407	16	35	P.O.A	×
26	432	17	35	P.O.A	×
27	457	18	35	P.O.A	×
28	483	19	35	P.O.A	×
29	508	20	70	P.O.A	×
30	534	21	40	P.O.A	×
31	559	22	*	P.O.A	×
32	584	23	65	P.O.A	×
33	610	24	*	P.O.A	×
34	635	25	*	P.O.A	×
35	660	26	*	P.O.A	×
36	686	27	*	P.O.A	×
37	711	28	*	P.O.A	×
38	737	29	*	P.O.A	×
39	762	30	*	P.O.A	×
40	787	31	*	P.O.A	×
41	813	32	*	P.O.A	×



Long radius 90° elbows

- White UV Stable.

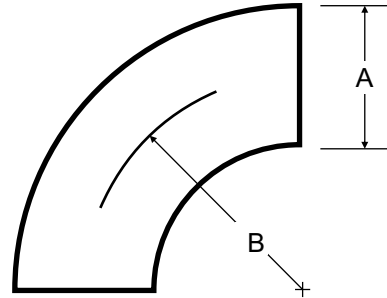
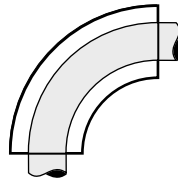

✓ These white fittings generally available ex stock.

× Available on special order. Conditions apply.

* Contact Factory for measurements.

Metric		Imperial		A-mm	B-mm		
NB	Wall	Inch NB	Wall				
80	13	3	?	115	133		×
100	13	4	?	140	171		×
125	13	5	?	166	210		×
150	13	6	?	194	252		×
200	13	8	?	245	300		×
50	25	2	1	110	90		×
65	25	2½	1	126	114		×
80	25	3	1	139	133		×
100	25	4	1	154	171		×
125	25	5	1	190	210		×
150	25	6	1	218	252		×
200	25	8	1	269	329		×
260	25	10	1	323	410		×
310	25	12	1	374	486		×
350	25	14	1	406	572	P.O.A	×
406	25	16	1	456	609	P.O.A	×
457	25	18	1	507	686	P.O.A	×
508	25	20	1	558	762	P.O.A	×
610	25	24	1	660	915	P.O.A	×
760	25	30	1	810	*	P.O.A	×



Long radius 90° elbows

- White UV Stable.

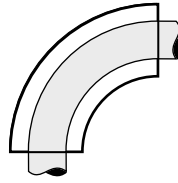

✓ These white fittings generally available ex stock.

× Available on special order. Conditions apply.

* Contact Factory for measurements.

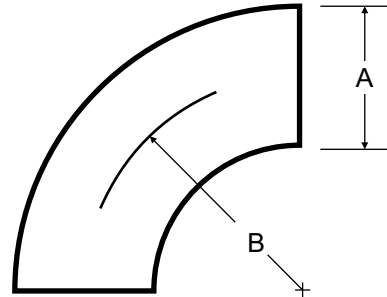

Metric		Imperial		A-mm	B-mm		
NB	Wall	Inch NB	Wall				
80	38	3	1½	165	*		×
100	38	4	1½	190	*		×
125	38	5	1½	216	*		×
150	38	6	1½	244	*		×
200	38	8	1½	295	*		×
260	38	10	1½	347	*		×
310	38	12	1½	400	*		×
350	38	14	1½	432	*		×
406	38	16	1½	482	*		×
457	38	18	1½	533	*		×
508	38	20	1½	584	*		×
610	38	24	1½	686	*		×
760	38	30	1½	836	*		×
915	38	36	1½	990	*		×
100	50	4	2	204	*		×
127	50	5	2	240	*		×
150	50	6	2	270	*		×
200	50	8	2	321	*		×
260	50	10	2	373	*		×
310	50	12	2	426	*	P.O.A	×
350	50	14	2	458	*	P.O.A	×
406	50	16	2	508	*	P.O.A	×



Long radius 90° elbows

- White UV Stable.

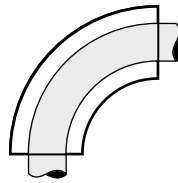

✓ These white fittings generally available ex stock.

× Available on special order. Conditions apply.

* Contact Factory for measurements.

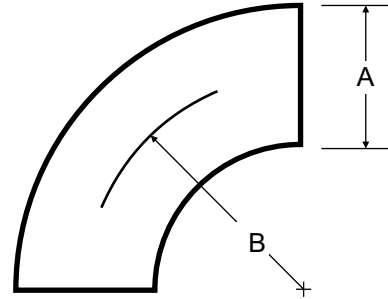

Metric		Imperial		A-mm	B-mm		
NB	Wall	Inch NB	Wall				
150	50	6	2	270	*		×
200	50	8	2	321	*		×
260	50	10	2	373	*		×
310	50	12	2	426	*		×
350	50	14	2	458	*	P.O.A	×
406	50	16	2	508	*	P.O.A	×
457	50	18	2	559	*	P.O.A	×
508	50	20	2	610	*	P.O.A	×
610	50	24	2	712	*	P.O.A	×
760	50	30	2	862	*	P.O.A	×
100	65	4	2½	234	*		×
125	65	5	2½	270	*		×
150	65	6	2½	300	*		×
200	65	8	2½	351	*		×
260	65	10	2½	403	*		×
310	65	12	2½	456	*	P.O.A	×
350	65	14	2½	488	*	P.O.A	×
406	65	16	2½	538	*	P.O.A	×
457	65	18	2½	589	*	P.O.A	×
508	65	20	2½	640	*	P.O.A	×
610	65	24	2½	742	*	P.O.A	×



Long radius 90° elbows

- White UV Stable.

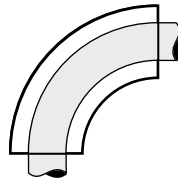

✓ These white fittings generally available ex stock.

× Available on special order. Conditions apply.

* Contact Factory for measurements.

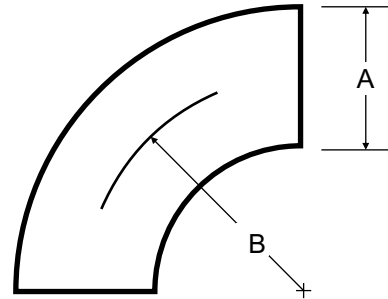

Metric		Imperial		A-mm	B-mm		
NB	Wall	Inch NB	Wall				
100	75	4	3	254	*		×
125	75	5	3	290	*		×
150	75	6	3	320	*		×
200	75	8	3	371	*		×
260	75	10	3	423	*		×
310	75	12	3	476	*	P.O.A	×
350	75	14	3	508	*	P.O.A	×
406	75	16	3	558	*	P.O.A	×
457	75	18	3	609	*	P.O.A	×
508	75	20	3	660	*	P.O.A	×
610	75	24	3	762	*	P.O.A	×
760	75	30	3	912	*	P.O.A	×
100	88	4	3½	280	*		×
150	88	6	3½	346	*		×
200	88	8	3½	397	*		×
260	88	10	3½	449	*		×
310	88	12	3½	502	*	P.O.A	×
350	88	14	3½	534	*	P.O.A	×
406	88	16	3½	584	*	P.O.A	×
457	88	18	3½	635	*	P.O.A	×
610	88	24	3½	788	*	P.O.A	×



Long radius 90° elbows

- White UV Stable.

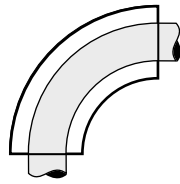

✓ These white fittings generally available ex stock.

× Available on special order. Conditions apply.

* Contact Factory for measurements.

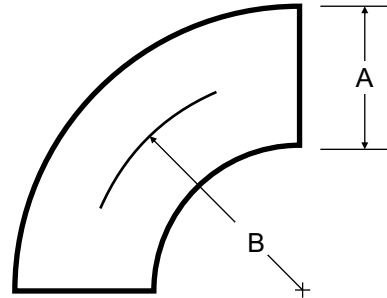

Metric		Imperial		A-mm	B-mm		
NB	Wall	Inch NB	Wall				
150	100	6	4	370	*		×
200	100	8	4	421	*		×
260	100	10	4	473	*		×
310	100	12	4	526	*	P.O.A	×
260	125	10	5	523	*	P.O.A	×
508	100	20	4	710	*	P.O.A	×

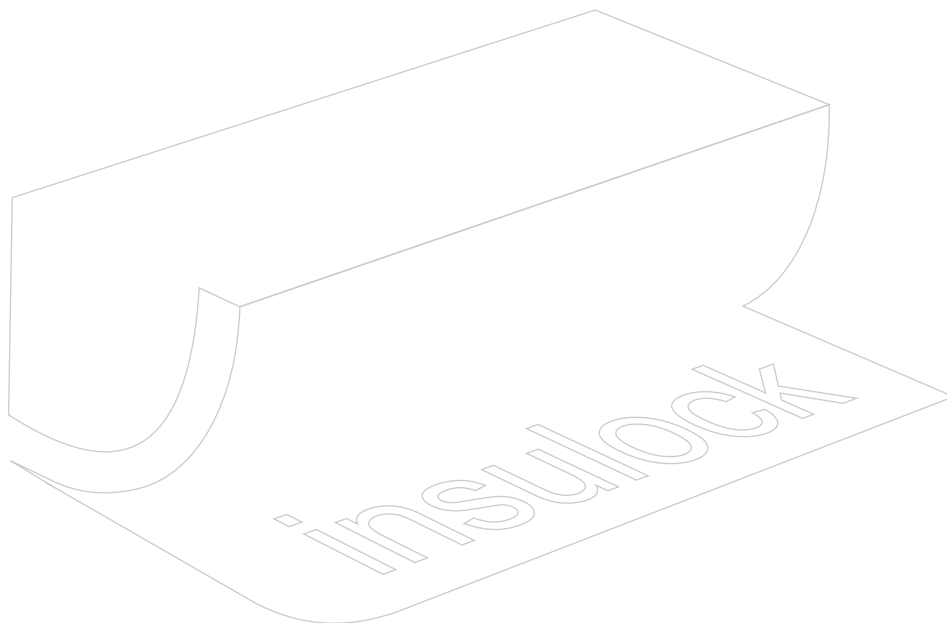



Line flange cover

- White UV Stable.

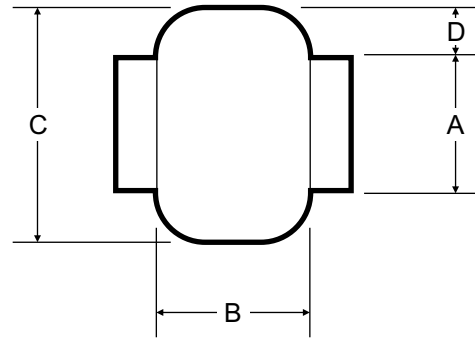
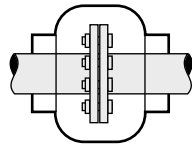

✓ These white fittings generally available ex stock.

✗ Available on special order. Conditions apply.

* Contact Factory for measurements.

Max Insulation O.D.
Coverable

Size	A-mm	inches	B-mm	C-mm	D-mm	
1	27	1 1/16	70	70	19	✗
3	47	1 7/8	89	82	19	✗
5	60	2 3/8	114	114	25	✗
6-7	73	2 7/8	152	191	57	✗
8-9	89	3 1/2	140	197	51	✗
10-11	114	4 1/2	184	216	51	✗
12-13	141	5 9/16	191	264	57	✗
14-15	168	6 5/8	203	305	70	✗
16-17-18	219	8 5/8	203	375	76	✗
19-20	273	10 3/4	241	394	76	✗
21-22	324	12 3/4	241	502	83	✗
23-24	381	15	292	572	89	P.O.A ✗
25-26	432	17	292	635	102	P.O.A ✗
27-28	483	19	356	730	124	P.O.A ✗
29-30	533	21	381	788	127	P.O.A ✗
31-32	584	23	388	851	127	P.O.A ✗
33-34	635	25	394	902	133	P.O.A ✗
35-36	686	27	432	952	146	P.O.A ✗
37-38	737	29	457	1003	152	P.O.A ✗



EXL-Line Flange Covers

- White UV Stable.
- Fire Tested AS1530.3

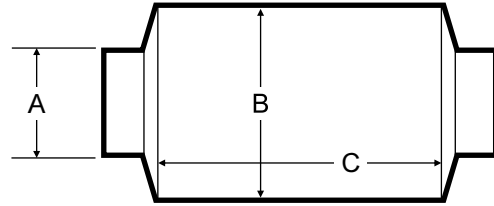
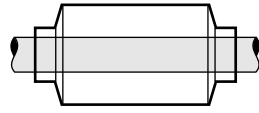

✓ These white fittings generally available ex stock.

× Available on special order. Conditions apply.

* Contact Factory for measurements.

Metric	Imperial					
Size	NB x Wall	Inch NB	B-mm OD	C-mm		
EX-L-FLG	15 x 25	½ x 1	141	254		×
EX-L-FLG	20 x 25	¾ x 1	168	254		×
EX-L-FLG	25 x 25	1 x 1	193	254		×
EX-L-FLG	40 x 25	1½ x 1	219	292		×
EX-L-FLG	50 x 25	2 x 1	219	292		×
EX-L-FLG	80 x 25	3 x 1	273	381		×
EX-L-FLG	100 x 25	4 x 1	323	381		×
EX-L-FLG	150 x 25	6 x 1	381	520		×
EX-L-FLG	200 x 25	8 x 1	432	571		×
EX-L-FLG	254 x 25	10 x 1	508	571		×
EX-L-FLG	310 x 25	12 x 1	584	622	P.O.A	×
EX-L-FLG	15 x 38	½ x 1½	168	254		×
EX-L-FLG	20 x 38	¾ x 1½	194	254		×
EX-L-FLG	25 x 38	1 x 1½	194	254		×
EX-L-FLG	38 x 38	1½ x 1½	244	292		×
EX-L-FLG	50 x 38	2 x 1½	244	292		×
EX-L-FLG	80 x 38	3 x 1½	298	381		×
EX-L-FLG	100 x 38	4 x 1½	356	381		×
EX-L-FLG	150 x 38	6 x 1½	406	520		×
EX-L-FLG	200 x 38	8 x 1½	457	571		×
EX-L-FLG	254 x 38	10 x 1½	533	571		×
EX-L-FLG	310 x 38	12 x 1½	609	622		×



EXL-Line Flange Covers

- White UV Stable.
- Fire Tested AS1530.3

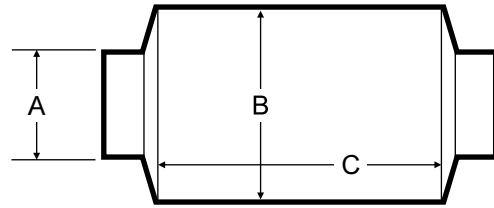
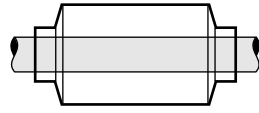

✓ These white fittings generally available ex stock.

× Available on special order. Conditions apply.

* Contact Factory for measurements.

Size	Metric	Imperial	B-mm OD	C-mm		
	NB x Wall	Inch NB				
EX-L-FLG	15 x 50	½ x 2	193	254	×	
EX-L-FLG	20 x 50	¾ x 2	219	254	×	
EX-L-FLG	25 x 50	1 x 2	244	254	×	
EX-L-FLG	40 x 50	1½ x 2	273	292	×	
EX-L-FLG	50 x 50	2 x 2	273	292	×	
EX-L-FLG	80 x 50	3 x 2	323	381	×	
EX-L-FLG	100 x 50	4 x 2	381	381	×	
EX-L-FLG	150 x 50	6 x 2	432	520	×	
EX-L-FLG	200 x 50	8 x 2	482	571	×	
EX-L-FLG	254 x 50	10 x 2	559	571	×	
EX-L-FLG	310 x 50	12 x 2	635	622	×	
EX-L-FLG	50 x 65	2 x 2½	298	292	×	
EX-L-FLG	80 x 65	3 x 2½	356	381	×	
EX-L-FLG	100 x 65	4 x 2½	406	381	×	
EX-L-FLG	150 x 65	6 x 2½	457	520	×	
EX-L-FLG	200 x 65	8 x 2½	508	571	×	
EX-L-FLG	254 x 65	10 x 2½	584	571	×	
EX-L-FLG	310 x 65	12 x 2½	660	622	P.O.A	×



Concentric cone reducer

Effective 1st March, 2007

- White UV Stable.
- Fire Tested AS1530.3

✓ These white fittings generally available ex stock.

× Available on special order. Conditions apply.

* Contact Factory for measurements.

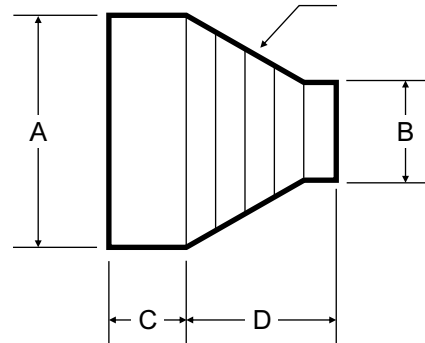

Max Insulation O.D.
Coverable

Size	A-mm	inches	B-mm	C-mm	D-mm	
6 - 3	67	2 1/2	48	45	50	×
9 - 2	89	3 1/2	41	45	50	×
12 - 2	127	5	41	75	75	×
15 - 5	168	6 5/8	60	95	75	×
18 - 9	219	8 5/8	89	110	75	×
22 -13	324	12 3/4	141	150	100	×
28 -15	483	19	168	267	165	×
39 - 27	762	30	457	*	*	P.O.A

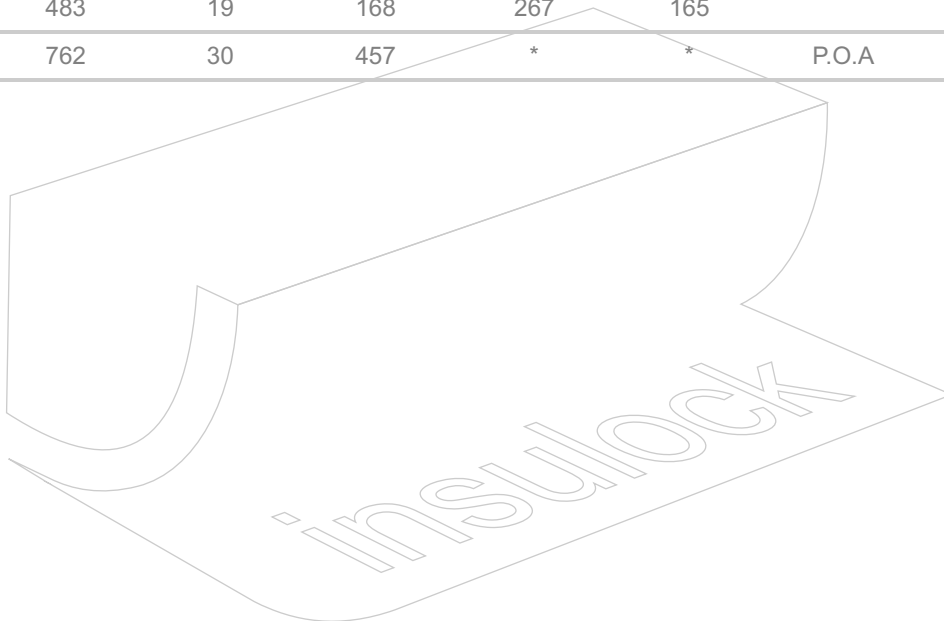



Flanged gate valve

- White UV Stable.
- Fire Tested AS1530.3

✓ These white fittings generally available ex stock.

× Available on special order. Conditions apply.

* Contact Factory for measurements.

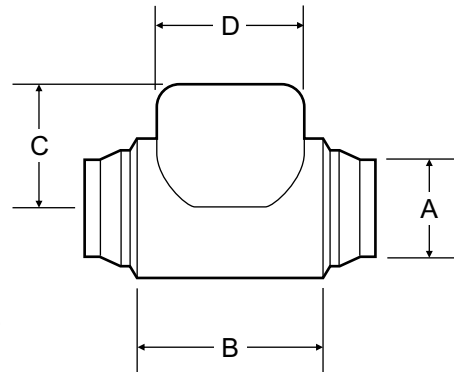

Max Insulation O.D.
Coverable

Size	A-mm	inches	B-mm	C-mm	D-mm	
219	219	8 5/8	290	210	185	×
244	244	9 5/8	340	190	215	×
244	244	9 5/8	340	190	215	×
273	273	10 3/4	380	170	240	×
273	273	10 3/4	380	230	240	×
323	323	12 3/4	405	230	265	×
323	323	12 3/4	405	255	265	×
355	355	14	355	275	300	×
323	323	12 3/4	405	290	265	×
355	355	14	430	310	300	×
381	381	15	460	310	310	×
457	457	18	490	405	345	×
508	508	20	520	430	345	×
508	508	20	520	430	345	×
584	584	23	560	530	405	×
635	635	25	610	635	430	P.O.A
762	762	30	635	710	485	P.O.A



90° flanged elbow

- White UV Stable.
- Fire Tested AS1530.3

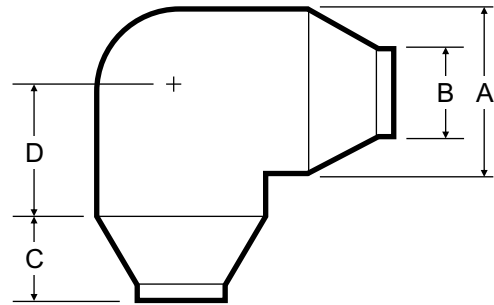
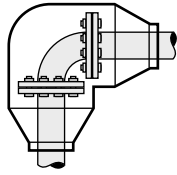

✓ These white fittings generally available ex stock.

× Available on special order. Conditions apply.

* Contact Factory for measurements.

Max Insulation O.D.
Coverable

Size	A-mm	inches	B-mm	C-mm	D-mm	
13S	141	5 9/16				×
14S		6 1/8	N/A-use 15S and cut reducer end to size			
15S	168	6 5/8				×
16S	180	7 1/8	N/A - use 17S and cut reducer end to size			
17S	194	7 5/8				×
18S	219	8 5/8				×
19S	244	9 5/8				×
20S	273	10 3/4				×
21S	298	11 3/4				×
22S	323	12 3/4				×
23S	355	14				×
24S	381	15				×
25S	406	16				×
26S	431	17				×
27S	457	18				×
28S	483	19				×
29S	508	20				×
30S	533	21				×
32S	584	23				P.O.A
33S	609	24				P.O.A



90° flanged elbow

- White UV Stable.
- Fire Tested AS1530.3

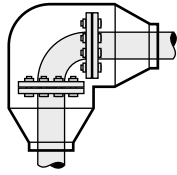

✓ These white fittings generally available ex stock.

× Available on special order. Conditions apply.

* Contact Factory for measurements.

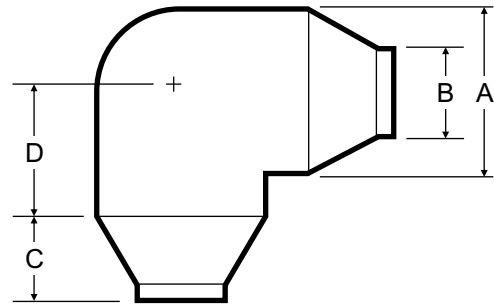

Max Insulation O.D.
Coverable

Size	A-mm	inches	B-mm	C-mm	D-mm		
34S	635	25				P.O.A	×
35S	660	26				P.O.A	×
37S	711	28				P.O.A	×
39S	762	30				P.O.A	×

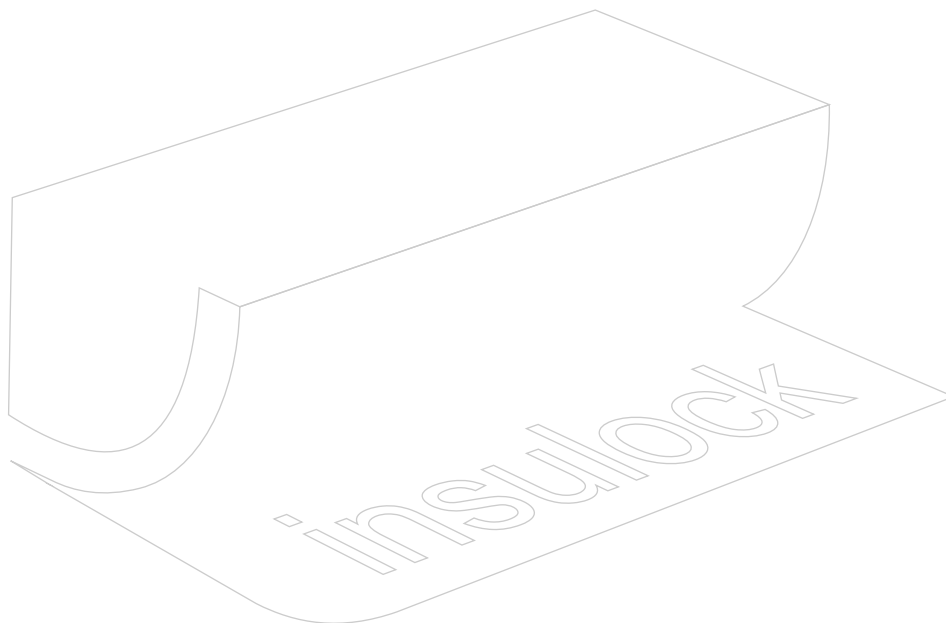



90° reducer elbow

- White UV Stable.
- Fire Tested AS1530.3

✓ These white fittings generally available ex stock.

× Available on special order. Conditions apply.

* Contact Factory for measurements.

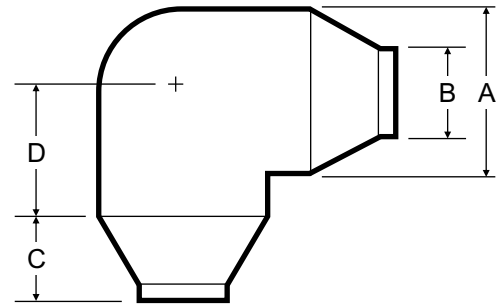

Max Insulation O.D.
Coverable

Size	A-mm	inches	B-mm	C-mm	D-mm	
3R	48	1 7/8	41	22	54	×
5R	60	2 3/8	48	27	60	×
7R	73	2 7/8	48	33	68	×
8R	79	3 1/8	N/A-use 9R and cut reducer end to size			
9R	89	3 1/2	48	40	76	×
10R	102	4	48	46	83	×
11R	114	4 1/2	48	51	89	×
12R	127	5	67	57	95	×
13R	141	5 9/16	67	63	133	×
14R	156	6 1/8	N/A - use 15R and cut reducer end to size			
15R	168	6 5/8	89	76	152	×
16R	181	7 1/8	N/A - use 17R and cut reducer end to size			
17R	194	7 5/8	65	89	171	×
18R	219	8 5/8	68	89	197	×
19R	244	9 5/8	75	127	216	×
20R	273	10 3/4	77	114	232	×
21R	298	11 3/4	100	127	254	×
22R	324	12 3/4	100	127	267	×
23R	356	14	105	178	292	P.O.A
24R	381	15	107	168	284	P.O.A



90° reducer elbow

- White UV Stable.
- Fire Tested AS1530.3

✓ These white fittings generally available ex stock.

× Available on special order. Conditions apply.

* Contact Factory for measurements.

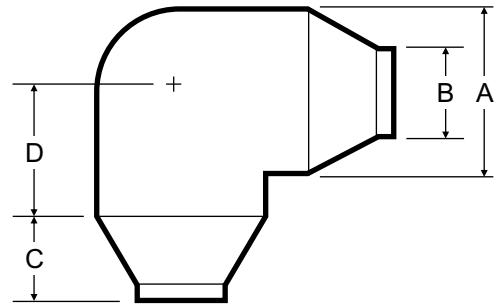

Max Insulation O.D.
Coverable

Size	A-mm	inches	B-mm	C-mm	D-mm		
25R	406	16	168	183	318	P.O.A	×
26R	432	17	216	194	264	P.O.A	×
27R	457	18	289	206	356	P.O.A	×
28R	483	19	267	217	508	P.O.A	×
29R	508	20	324	229	483	P.O.A	×
30R	533	21	356	240	584	P.O.A	×
31R	559	22	356	252	559	P.O.A	×
32R	584	23	267	263	483	P.O.A	×
33R	610	24	356	275	686	P.O.A	×
34R	635	25	*	286	*	P.O.A	×
35R	660	26	457	297	610	P.O.A	×
36R	686	27	407	309	787	P.O.A	×
37R	711	28	508	320	559	P.O.A	
38R	737	29	*	332	*	P.O.A	
39R	762	30	762	343	762	P.O.A	



45° reducer elbow

- White UV Stable.
- Fire Tested AS1530.3

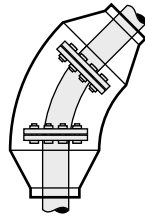

✓ These white fittings generally available ex stock.

× Available on special order. Conditions apply.

* Contact Factory for measurements.

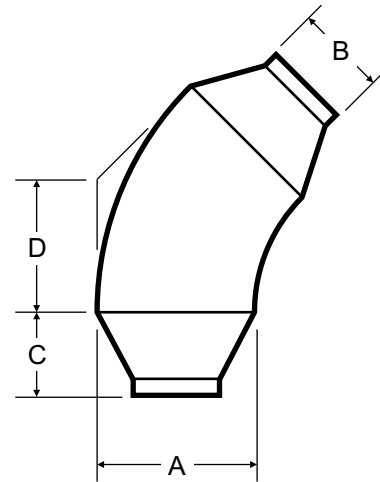

Max Insulation O.D.
Coverable

Size	A-mm	inches	B-mm	C-mm	D-mm	
3R	48	1 7/8	41	22	54	×
5R	60	2 3/8	48	27	60	×
7R	73	2 7/8	48	33	68	×
8R	79	3 1/8	N/A-use 9R and cut reducer end to size			
9R	89	3 1/2	48	40	76	×
10R	102	4	48	46	83	×
11R	114	4 1/2	48	51	89	×
12R	127	5	67	57	95	×
13R	141	5 9/16	67	63	133	×
14R	156	6 1/8	N/A - use 15R and cut reducer end to size			
15R	168	6 5/8	89	76	152	×
16R	181	7 1/8	N/A - use 17R and cut reducer end to size			
17R	194	7 5/8	65	89	171	×
18R	219	8 5/8	68	89	197	×
19R	244	9 5/8	75	127	216	×
20R	273	10 3/4	77	114	232	×
21R	298	11 3/4	100	127	254	×
22R	324	12 3/4	100	127	267	×
23R	356	14	105	178	292	P.O.A
24R	381	16	107	168	284	P.O.A



45° reducer elbow

- White UV Stable.
- Fire Tested AS1530.3

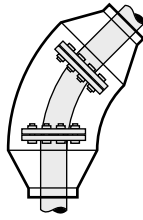

✓ These white fittings generally available ex stock.

× Available on special order. Conditions apply.

* Contact Factory for measurements.

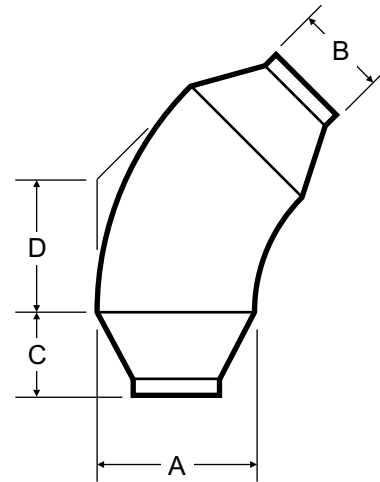

Max Insulation O.D.
Coverable

Size	A-mm	inches	B-mm	C-mm	D-mm		
25R	406	16	168	183	318	P.O.A	×
26R	432	17	216	194	264	P.O.A	×
27R	457	18	289	206	356	P.O.A	×
28R	483	19	267	217	508	P.O.A	×
29R	508	20	324	229	483	P.O.A	×
30R	533	21	356	240	584	P.O.A	×
31R	559	22	356	252	559	P.O.A	×
32R	584	23	267	263	483	P.O.A	×
33R	610	24	356	275	686	P.O.A	×
34R	635	25	*	286	*	P.O.A	×
35R	660	26	457	297	610	P.O.A	×
36R	686	27	407	309	787	P.O.A	×
37R	711	28	508	320	559	P.O.A	×
38R	737	29	*	332	*	P.O.A	×
39R	762	30	762	343	762	P.O.A	×



Flanged tee

- White UV Stable.
- Fire Tested AS1530.3

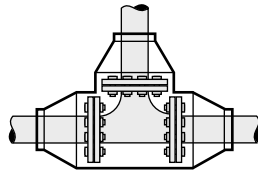

✓ These white fittings generally available ex stock.

× Available on special order. Conditions apply.

* Contact Factory for measurements.

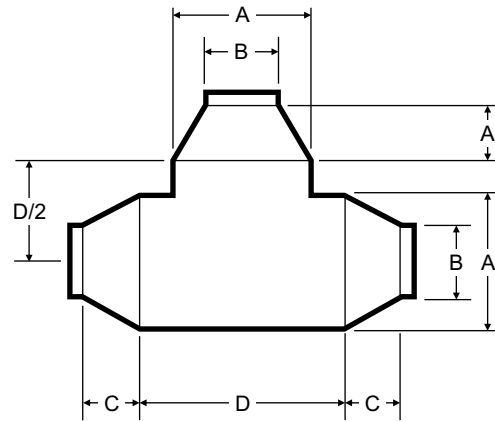

Max Insulation O.D.

Size	A-mm	inches	B-mm	C-mm	D-mm	
13S	141	5 9/16				×
14S		6 1/8	N/A-use 15S and cut reducer end to size			
15S	168	6 5/8				×
16S	180	7 1/8	N/A - use 17S and cut reducer end to size			
17S	194	7 5/8				×
18S	219	8 5/8				×
19S	244	9 5/8				×
20S	273	10 3/4				×
21S	298	11 3/4				×
22S	323	12 3/4				×
23S	355	14				×
24S	381	15				×
25S	406	16				×
26S	431	17				×
27S	457	18				×
28S	483	19				×
29S	508	20				×
30S	533	21				×
32S	584	23				P.O.A
33S	609	24				P.O.A



Flanged tee

- White UV Stable.
- Fire Tested AS1530.3

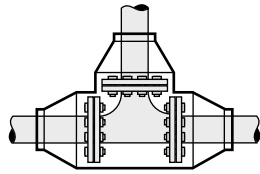

- ✓ These white fittings generally available ex stock.
- × Available on special order. Conditions apply.
- * Contact Factory for measurements.

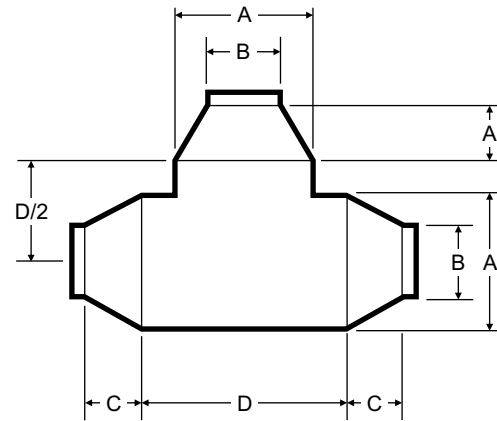

Max Insulation O.D.

Size	A-mm	inches	B-mm	C-mm	D-mm		
34S	635	25				P.O.A	×
35S	660	26				P.O.A	×
37S	711	28				P.O.A	×
39S	762	30				P.O.A	×

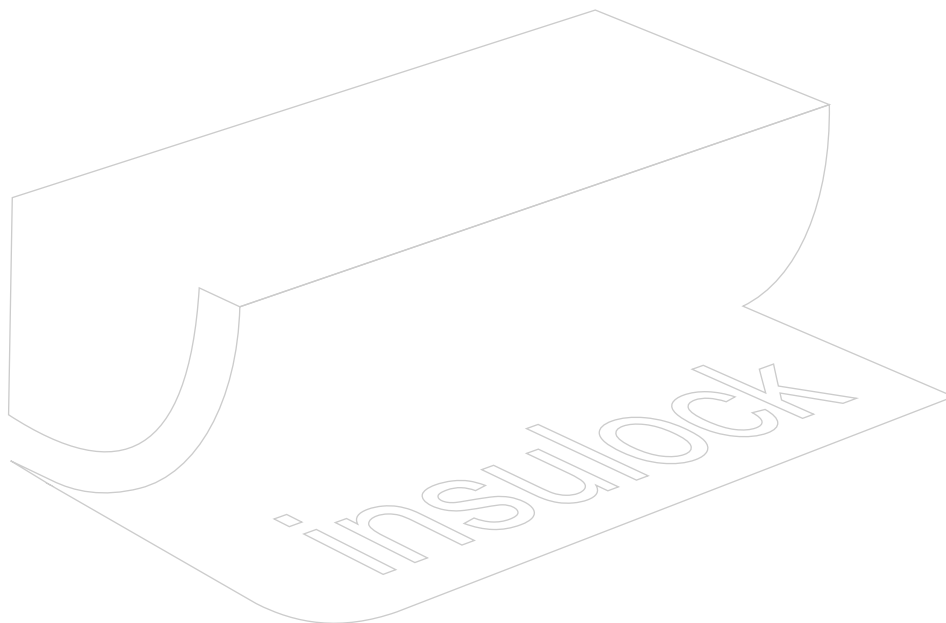



Reducer tee

- White UV Stable.
- Fire Tested AS1530.3

✓ These white fittings generally available ex stock.

× Available on special order. Conditions apply.

* Contact Factory for measurements.

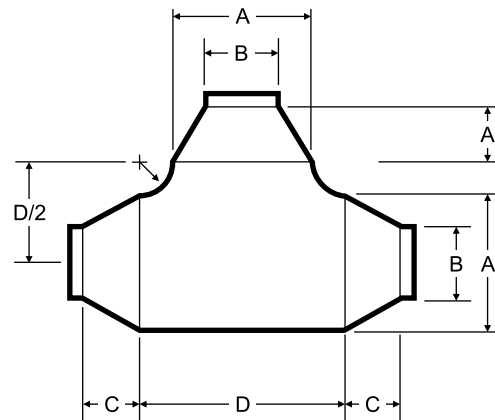

Max Insulation O.D.
Coverable

Size	A-mm	inches	B-mm	C-mm	D-mm	
3R	48	1 7/8	41	22	108	×
5R	60	2 3/8	48	27	121	×
7R	73	2 7/8	48	33	137	×
8R	79	3 1/8	N/A-use 9R and cut reducer end to size			
9R	89	3 1/2	48	40	152	×
10R	102	4	48	46	165	×
11R	114	4 1/2	48	51	178	×
12R	127	5	67	57	191	×
13R	141	5 9/16	67	63	267	×
14R	156	6 1/8	N/A - use 15R and cut reducer end to size			
15R	168	6 5/8	89	76	305	×
16R	181	7 1/8	N/A - use 17R and cut reducer end to size			
17R	194	7 5/8	65	89	343	×
18R	219	8 5/8	68	89	394	×
19R	244	9 5/8	75	127	432	×
20R	273	10 3/4	77	114	464	×
21R	298	11 3/4	100	127	508	×
22R	324	12 3/4	100	127	533	×
23R	356	14	105	178	584	P.O.A
24R	381	16	107	168	568	P.O.A



Reducer tee

- White UV Stable.
- Fire Tested AS1530.3

✓ These white fittings generally available ex stock.

× Available on special order. Conditions apply.

* Contact Factory for measurements.

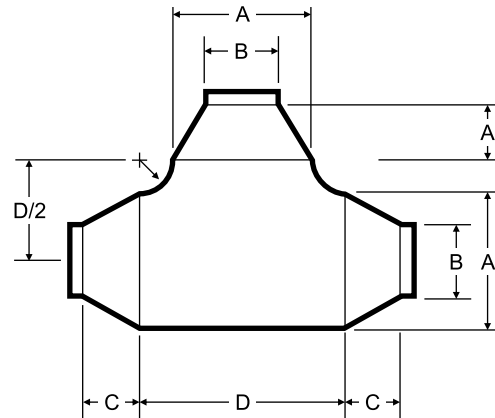

Max Insulation O.D.
Coverable

Size	A-mm	inches	B-mm	C-mm	D-mm		
25R	407	16	168	183	635	P.O.A	×
26R	432	17	216	194	527	P.O.A	×
27R	457	18	289	206	711	P.O.A	×
28R	483	19	267	217	1016	P.O.A	×
29R	508	20	324	229	965	P.O.A	×
30R	534	21	356	240	1168	P.O.A	×
31R	559	22	356	252	1118	P.O.A	×
32R	584	23	267	263	965	P.O.A	×
33R	610	24	356	275	1372	P.O.A	×
34R	635	25	*	286	*	P.O.A	×
35R	660	26	457	297	1219	P.O.A	×
36R	686	27	407	309	1575	P.O.A	×
37R	711	28	508	320	1118	P.O.A	×
38R	737	29	*	332	*	P.O.A	×
39R	762	30	762	343	1524	P.O.A	×



Victaulic 90° Covers

- White UV Stable.
- Fire Tested AS1530.3

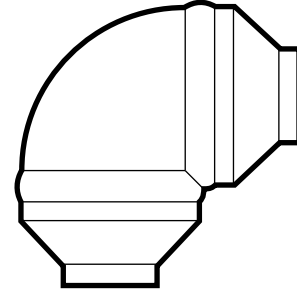
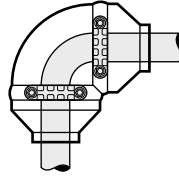

✓ These white fittings generally available ex stock.

× Available on special order. Conditions apply.

* Contact Factory for measurements.

Metric		Imperial			
NB	Max Wall	Inch NB	Max Wall		
26.9	38	¾	1 ½	×	
33.7	38	1	1½	×	
42.4	38	1 ¼	1½	×	
48.3	38	1 ½	1½	×	
60.3	50	2	2	×	
76.1	50	2 ½	2	×	
88.9	50	3	2	×	
101.6	50	3 ½	2	×	
114.3	50	4	2	×	
139.7	50	5	2	×	
168.3	50	6	2	×	
219.1	50	8	2	×	
273	38	10	2	×	
323.9	50	12	2	×	
381.0	63	14	2 ½	×	
168.3	75	6	3	×	
219.1	75	8	3	×	
273	75	10	3	×	
323.9	75	12	3	P.O.A	×
406.4	88	16	3 ½	P.O.A	×
457.0	88	18	3 ½	P.O.A	×

All covers have tapered ends to accommodate multiple Insulation Thickness: 13mm through 50mm thick on 150mm NB and greater pipe sizes. 13mm through 38mm thick on 127mm NB and smaller pipe sizes. Cut tapered ends to accommodate pipe insulation thickness



Victaulic 90° Long Radius Elbows

- White UV Stable.
- Fire Tested AS1530.3

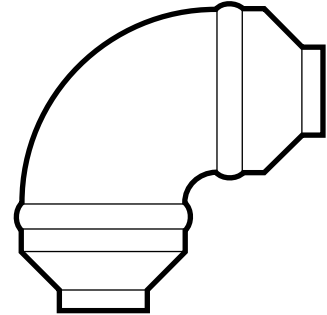
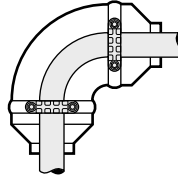

✓ These white fittings generally available ex stock.

× Available on special order. Conditions apply.

* Contact Factory for measurements.

Metric		Imperial		
NB	Wall	Inch NB	Wall	
	88	20	3½	×

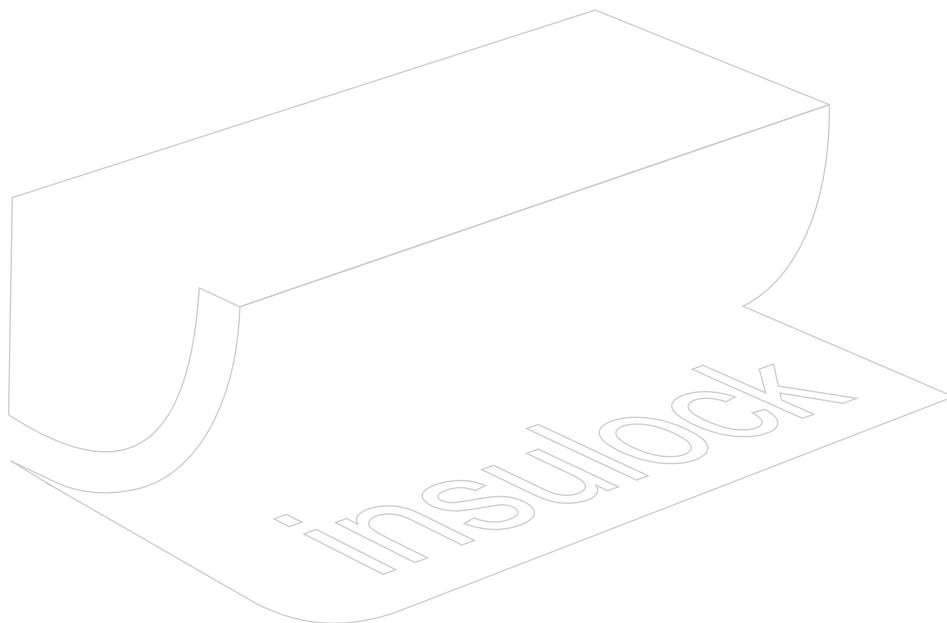



Victaulic 45° Covers

- White UV Stable.
- Fire Tested AS1530.3

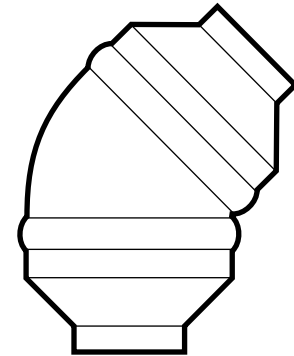
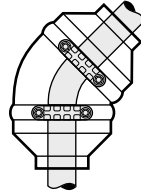

✓ These white fittings generally available ex stock.

× Available on special order. Conditions apply.

* Contact Factory for measurements.

Metric		Imperial		\$ ea.	
NB	Max Wall	Inch NB	Max Wall		
26.9	38	¾	1 ½	19.35	×
33.7	38	1	1½	21.42	×
42.4	38	1 ¼	1½	25.92	×
48.3	38	1 ½	1½	27.29	×
60.3	50	2	2	35.43	×
76.1	50	2 ½	2	47.62	×
88.9	50	3	2	53.54	×
101.6	50	3 ½	2	56.60	×
114.3	50	4	2	66.76	×
139.7	50	5	2	85.26	×
168.3	50	6	2	112.55	×
219.1	50	8	2	137.35	×
273	38	10	2	175.71	×
323.9	50	12	2	252.70	×
381.0	63	14	2 ½	342.17	×
168.3	75	6	3	143.93	×
219.1	75	8	3	170.39	×
273	75	10	3	234.12	×
323.9	75	12	3	311.76	×
406.4	88	16	3 ½	471.32	×
457.0	88	18	3 ½	648.36	×

All covers have tapered ends to accommodate multiple Insulation Thickness: 13mm through 50mm thick on 150mm NB and greater pipe sizes. 13mm through 38mm thick on 127mm NB and smaller pipe sizes. Cut tapered ends to accommodate pipe insulation thickness



Victaulic Grooved Couplings

- White UV Stable.
- Fire Tested AS1530.3

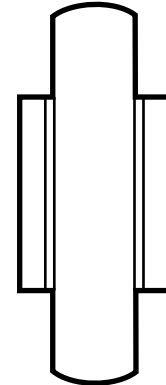
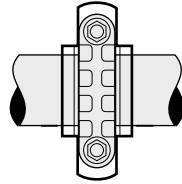

- ✓ These white fittings generally available ex stock.
- × Available on special order. Conditions apply.
- * Contact Factory for measurements.

Size	Fits: Pipe Size NB x Insulation Thickness						
#5-6	Fits pipe size with a maximum O.D of 67mm						×
#7-8-9	Fits pipe size with a maximum O.D of 89mm						×
#10-11-12	Fits pipe size with a maximum O.D of 127mm						×
#13	114 x 13	88 x 25	60 x 38	42 x 50	25 x 50		×
#14-15	139 x 13	114 x 25	88 x 38	76 x 38	50 x 50	48 x 50	×
#16-17	168 x 13	139 x 25	114 x 38	101 x 38	88 x 50	60 x 50	×
#18	168 x 25	139 x 38	114 x 50	101 x 50	88 x 65		×
#19-20	219 x 13	168 x 38	139 x 65	139 x 50	114 x 65	114 x 75	×
#21-22	273 x 13	273 x 25	219 x 38	219 x 25	168 x 65	168 x 75	×
#23-24	323 x 25	273 x 38	273 x 50	219 x 65	219 x 75		×
#25-26	355 x 25	355 x 38	323 x 38	323 x 50	273 x 65	273 x 75	×
#27-30	406 x 25	406 x 38	406 x 50	406 x 65	355 x 50	355 x 65	×
	355 x 75	323 x 65	323 x 75				
#31-33	508 x 25	508 x 38	508 x 50	457 x 65	457 x 75		×
#34-36	*	*	*	*	*		×
#37-39	*	*	*	*	*		×

These Coupling covers can easily be squeezed down to fit a smaller size. For this reason, many of the sizes above, fit more than one size. Covers cannot be spread open to fit a larger size than the Max. O.D. given. Order larger size if in doubt or consult factory.



Victaulic Valve Tee Covers

Effective 1st March, 2007

- White UV Stable.
- Fire Tested AS1530.3

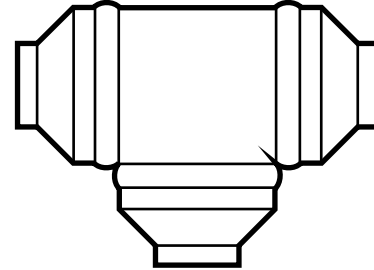
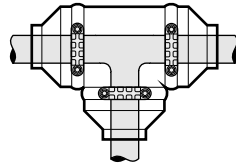

✓ These white fittings generally available ex stock.

× Available on special order. Conditions apply.

* Contact Factory for measurements.

Metric		Imperial			
NB	Max Wall	Inch NB	Max Wall		
26.9	38	¾	1 ½		×
33.7	38	1	1½		×
42.4	38	1 ¼	1½		×
48.3	38	1 ½	1½		×
60.3	50	2	2		×
76.1	50	2 ½	2		×
88.9	50	3	2		×
101.6	50	3 ½	2		×
114.3	50	4	2		×
139.7	50	5	2		×
168.3	50	6	2		×
219.1	50	8	2		×
273	38	10	2		×
323.9	50	12	2		×
381.0	63	14	2 ½		×
168.3	75	6	3		×
219.1	75	8	3		×
273	75	10	3		×
323.9	75	12	3	P.O.A	×
406.4	88	16	3 ½	P.O.A	×
457.0	88	18	3 ½	P.O.A	×

All covers have tapered ends to accommodate multiple Insulation Thickness: 13mm through 50mm thick on 150mm NB and greater pipe sizes. 13mm through 38mm thick on 127mm NB and smaller pipe sizes. Cut tapered ends to accommodate pipe insulation thickness



Sizing Chart

PVC Fitting Covers

Black steel pipe

Black Steel		Insulation Wall						
Inch	mm	O.D	Insulation Thickness					
N.B	N.B		½" 13mm	1" 25mm	1½" 38mm	2" 50mm	2½" 65mm	3" 75mm
½	15	21.3	3	7	10	12	14	16
¾	20	26.9	4	7	10	12	14	16
1	25	33.7	5	9	11	13	15	16
1 ¼	32	42.4	6	9	11	13	15	17
1 ½	40	48.3	7	10	12	14	16	17
Pipe Size → 2	50	60.3	9	11	13	15	17	18
2 ½	65	76.1	10	12	14	16	18	18
3	80	88.9	11	13	15	17	18	19
3 ½	90	101.6	12	14	16	18	19	20
4	100	114.3	13	15	17	18	19	20
5	127	139.7	15	17	18	19	20	21
6	150	168.3	17	18	19	20	21	22
8	200	219.1	19	20	21	22	23	24
10	254	273	21	22	23	24	25	26
12	310	323.9	23	24	25	26	27	28
14		355.6	24	25	26	27	28	29
16		406.4	26	27	28	29	30	31
18		457.2	28	29	30	31		
20		508	30	31				

Please contact factory regarding correct sizing for larger pipes, quoting pipe size, insulation thickness and insulation type.

The above are combination sizes that fit short and long radius screwed and welded elbows, long radius weld ells, and screwed welded tees.

Fitting sizes in shaded area will not fit most long radius 90° elbows properly; order fitting covers for these long radius 90° sizes by specific pipe size and insulation thickness. The above combination size will fit all 45° elbows.

Also use this chart for PVC and Galvanised Pipe.



Sizing Chart

PVC Fitting Covers

Copper & Stainless steel tube

Insulation Wall
↓
Insulation Thickness

Inches	Copper Tube Size mm	½" 13mm	1" 25mm	1½" 38mm	2" 50mm	2½" 65mm	3" 75mm
½	12.7	2	5	9	11	13	15
¾	19.1	3	6	10	11	14	15
1	25.4	4	7	10	12	14	16
1 ¼	31.8	5	8	11	13	15	16
1 ½	38.1	6	9	11	13	15	17
2	50.8	7	10	12	14	16	17
2 ½	63.5	9	11	13	15	17	18
3	76.2	10	12	14	16	18	19
3 ½	88.9	11	13	15	17	18	19
4	101.6	12	14	16	18	19	20
5	127.0	14	16	18	19	20	21
6	152.4	16	18	19	20	21	21

Tube Size →

Insulock recommends contacting factory if doubtful as to the correct size to order. Please specify pipe size, insulation thickness and insulation type.



Terms and Conditions of Sale

Definition

As used herein, the term "SELLER" shall mean insulock.

General

The seller shall not be liable for any delay or default in delivering products where occasioned by any cause of any kind or extent beyond the control of the seller, including without limitation: armed conflict or economic dislocation resulting there from: embargoes; shortages of labour; raw materials; fuel; energy; production facilities or transportation; labour difficulties; civil disorders of any kind; action of civil or military authorities (including priorities and allocations); fires; floods; and accidents. It is intended that no liability shall be sustained by the seller by reason of its not filling any order or portion thereof affected by such occurrence.

Order requiring affidavits or certificates or compliance must so state when orders are placed.

Orders

No order placed with the seller shall be considered to be accepted until officially acknowledged in writing by the seller. The terms and conditions stated therein, when combined with the seller's regular detailed terms and conditions and price pages, constitute the entire contract between the parties. Contrary or additional terms and conditions submitted by anyone other than the seller are specifically rejected and shall be deemed to be of no effect.

Tax

Any tax or other Governmental charge upon the production, sale, or shipment of products imposed by federal, state, municipal or other authorities shall be added to the price and must be paid by the purchaser.

Warranty

All shipments of the product sold hereby are subject to the following warranty:

The seller warrants for a period of one year from date of delivery that the product is free from defects in material and workmanship. This limited warranty is your exclusive warranty from the seller and describes the exclusive remedy available to any purchaser of the product. The product is not sold with any implied warranties, not any warranty or merchantability and/or other warranty of fitness for a particular purpose. In the sale of the product the seller makes no representation or warranty of any kind other than that stated herein.

Claims

Any claim on account of damaged products, warranty, short count or for any other cause shall be deemed waived unless made in writing within 30 days from the date of defect or cause to which each claim relates is discovered or should have been discovered.

Non Consequential Damages

Limitation of Liability. It is expressly understood and agreed that the limit of the seller's shall be, at the seller's sole option, repair or resupply of the product. Resupply shall mean furnishing free of charge, (F.O.B. place of original purchase) a new shipment of the product (uninstalled) in an amount sufficient to replace any product found to be defective. All labour and service charges which may be incurred with respect to either the original or replacement product are excluded. The seller shall not be liable for any incidental consequential or other damages which are based upon alleged negligence, breach or warranty, strict liability or any other theory other than the limited liability set forth above. Incidental and consequential damages shall not be recoverable even if the resupply remedy fails of its purpose or for any other reason.

Receiving

At time of delivery, customer should inspect for damage, and count the number of cartons received. This number should match the number on the carrier's consignment note. If it does not, it should be noted on the Packaging Slip at the time of delivery and Insulock Pty. Ltd. Should be notified of the shortage immediately on (03) 9720 9595. No replacement can be made, nor claim honoured if shortages are not noted on the packing slip.

Returns

No returns of products will be accepted without prior written approval. Where returns are authorised due to causes for which the seller is responsible, the seller will assume all charges and the full purchase price will be credited. When returns are made for the convenience of the purchaser at his request and these are approved in advance, in writing, by the seller, such products returned to the shipping point will be credited at the purchase price less all freight charges, including stopover charges absorbed by the seller on the original shipment to the purchaser and full freight charges on the return. The seller will also charge for handling and reconditioning. Credit will be based upon the quantity received in the seller's shipping points in resalable condition, as determined by the seller, plus 15% handling charge.

Modification or Termination

The terms and conditions of sale which constitute the contract between these parties are subject to change without notification and are effective immediately upon such notification.